

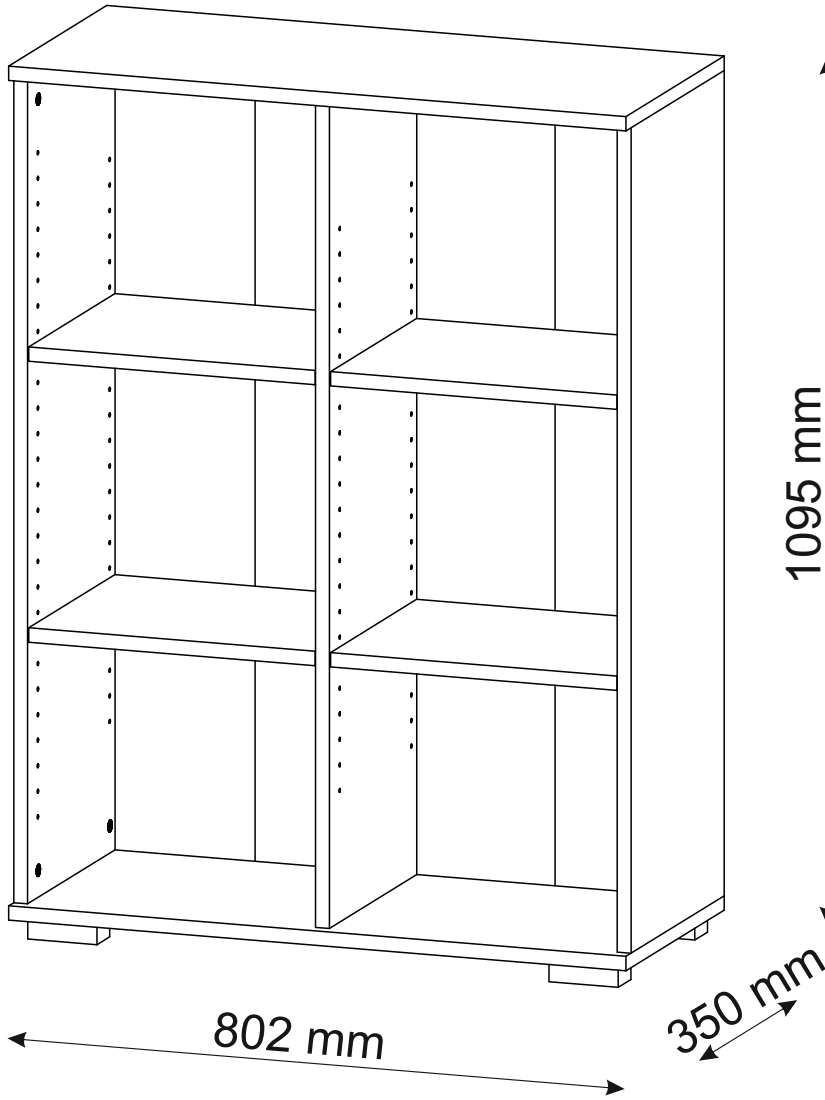

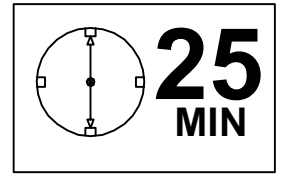

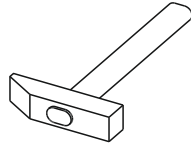

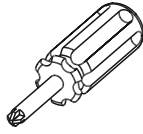
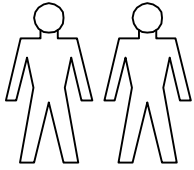
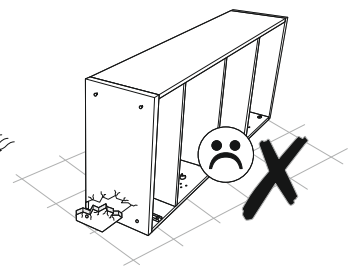
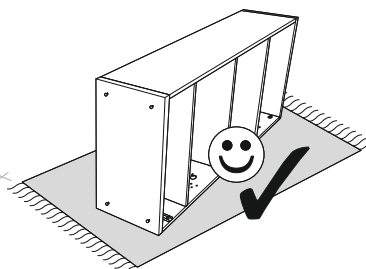
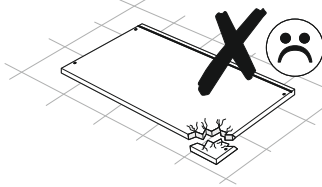
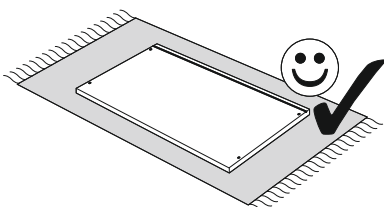
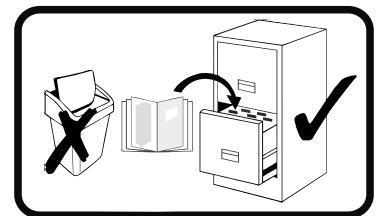
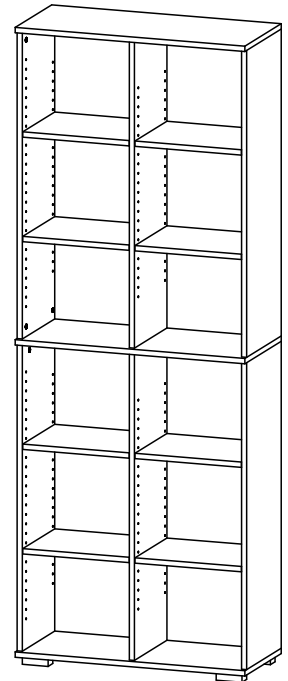

MUTATIO - Regal



option



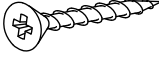

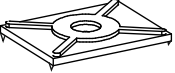
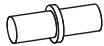
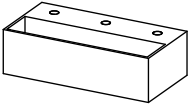
MUTATIO - Regal

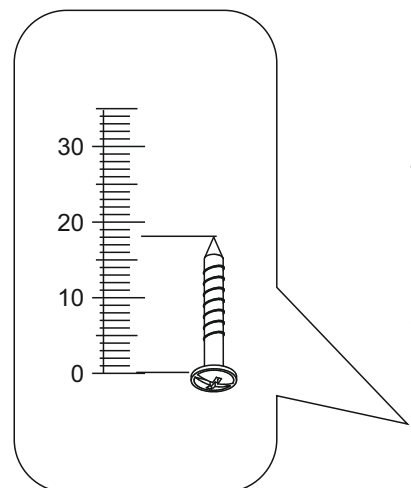
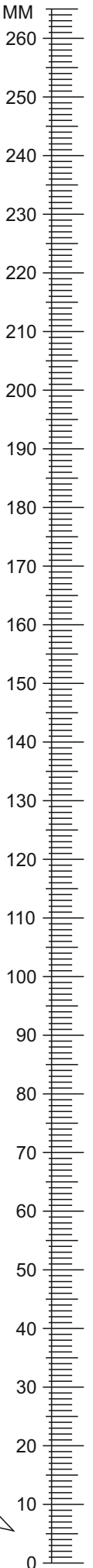
A0 8 x 30mm 	C0 	C1 18mm 
C2 	D0 3 x 15 mm 	D14 4 x 35 mm 
M1 	M3 	Q0 
T2 		

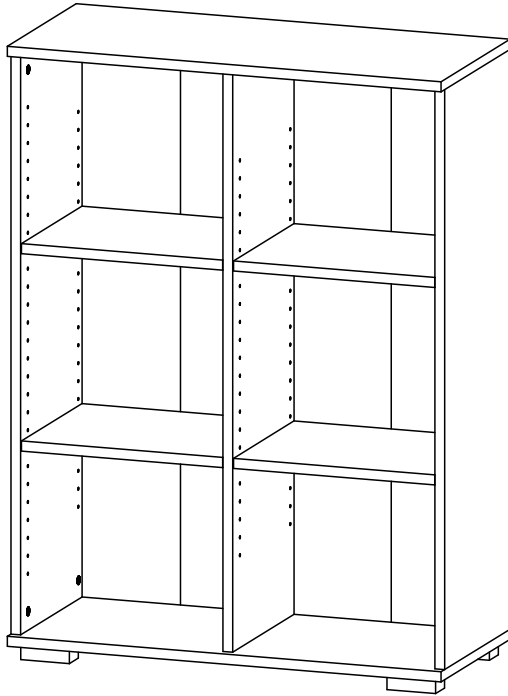

MUTATIO - Regal



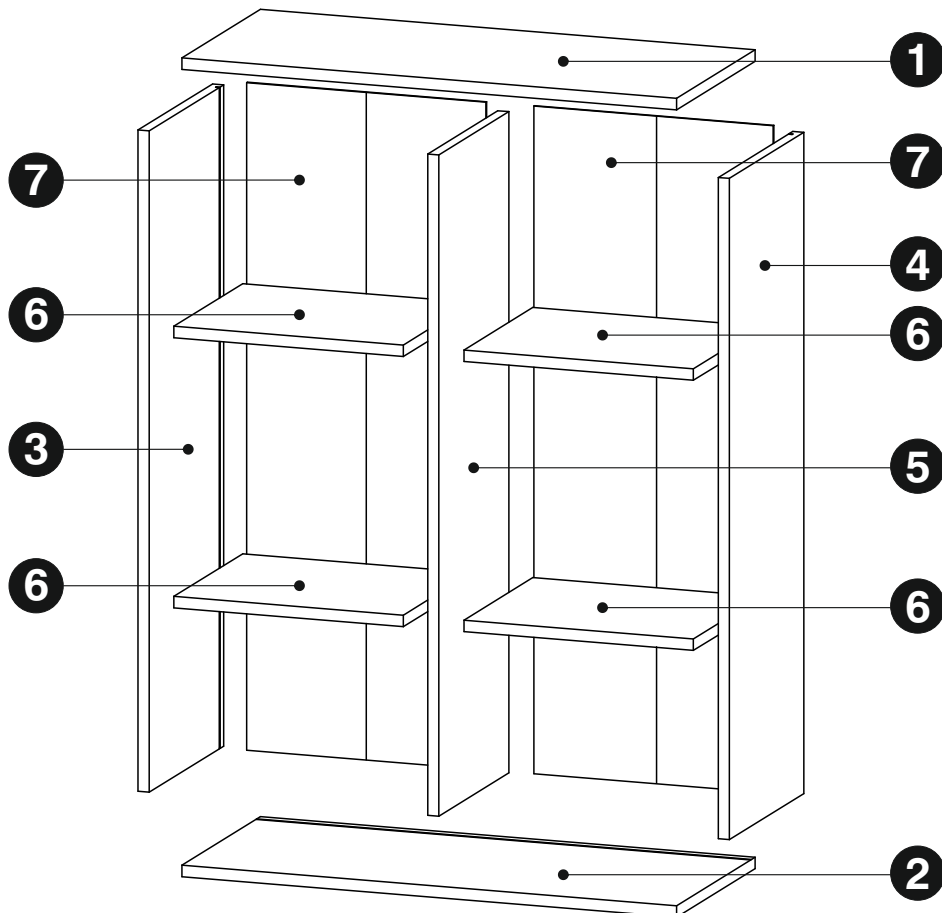

1	802	350	18	x1	1/1
2	802	350	18	x1	1/1
3	1034	332	18	x1	1/1
4	1034	332	18	x1	1/1
5	1034	312	18	x1	1/1
6	372	307	18	x4	1/1
7	1044	387	3	x2	1/1
					1/1

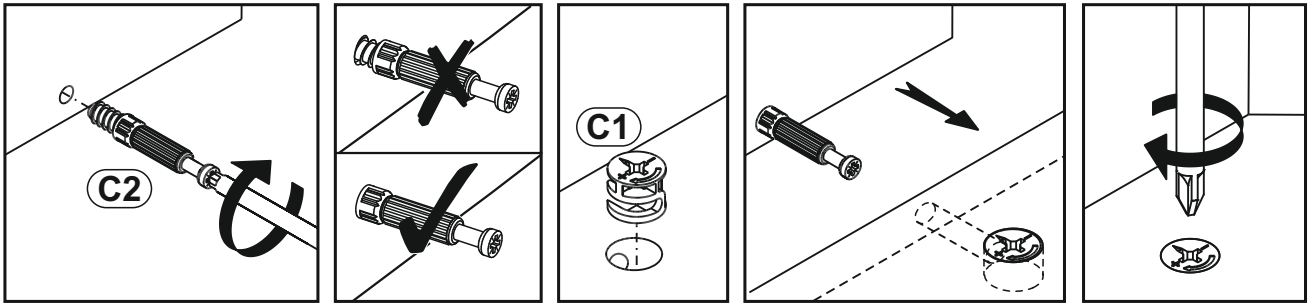



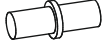

1 ▶

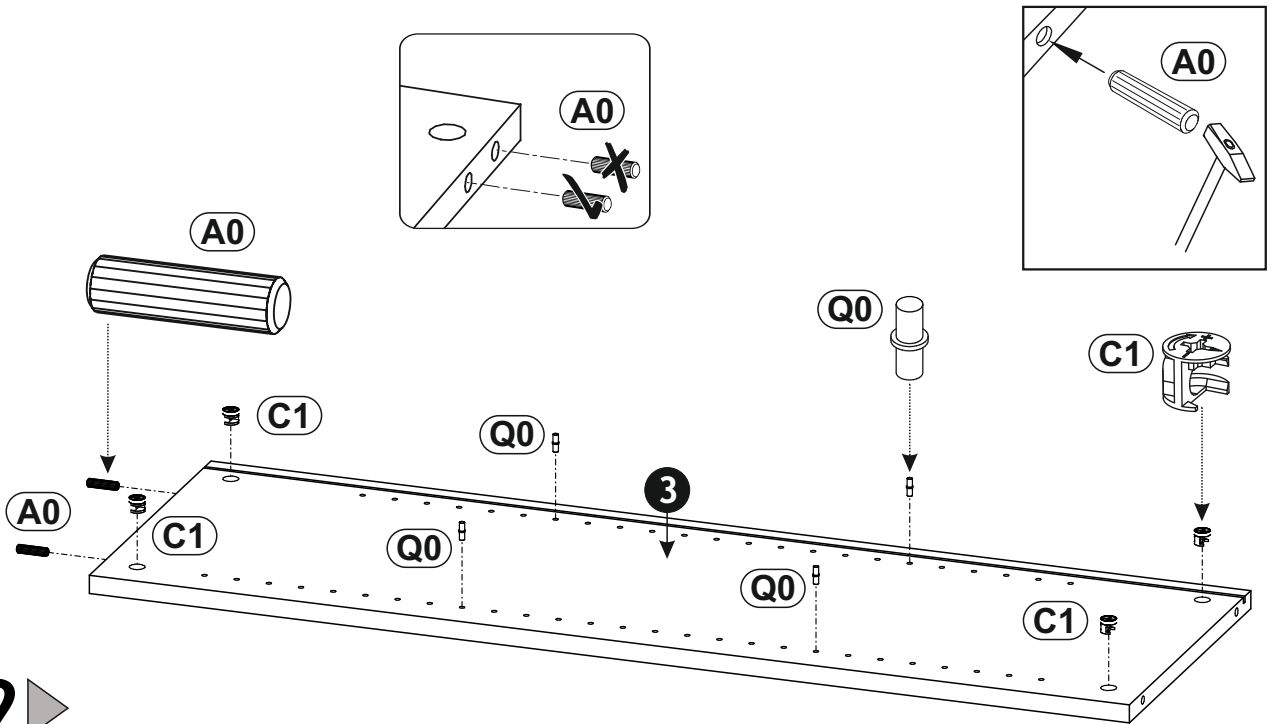
A0	8 x 30mm	x2	C1	18mm	x4	Q0	x4
							

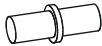

2 ▶

A0	8 x 30mm	x2	C1	18mm	x4	Q0	x4
							

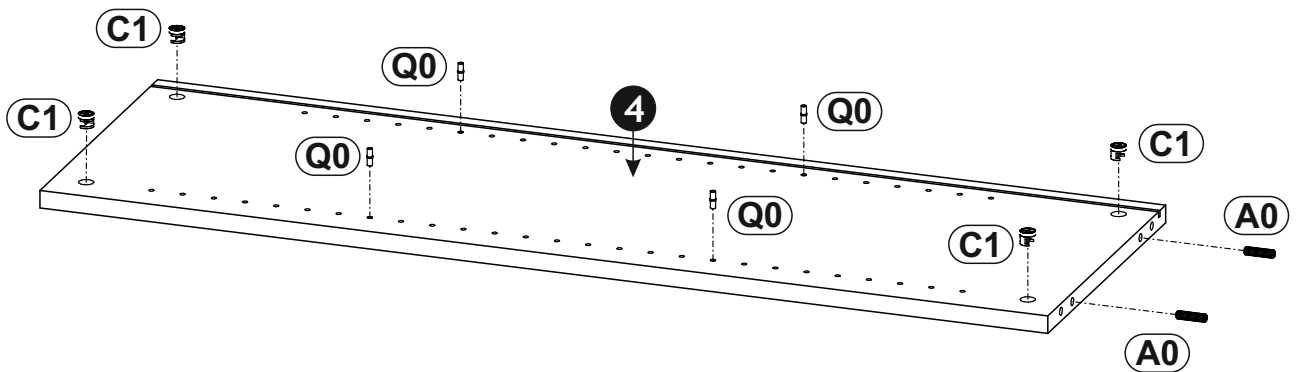

3 ▶

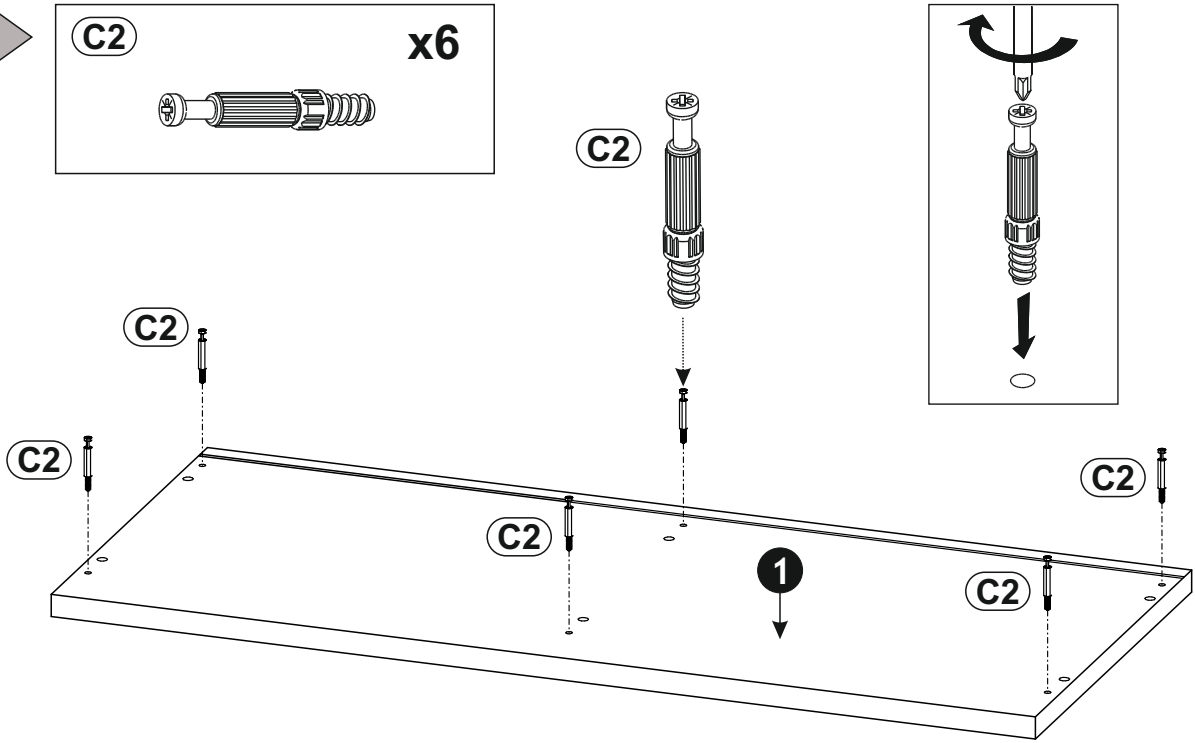
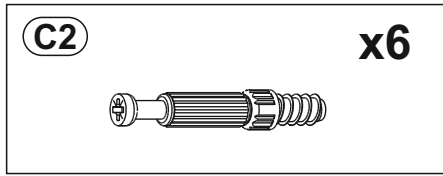

4 ▶

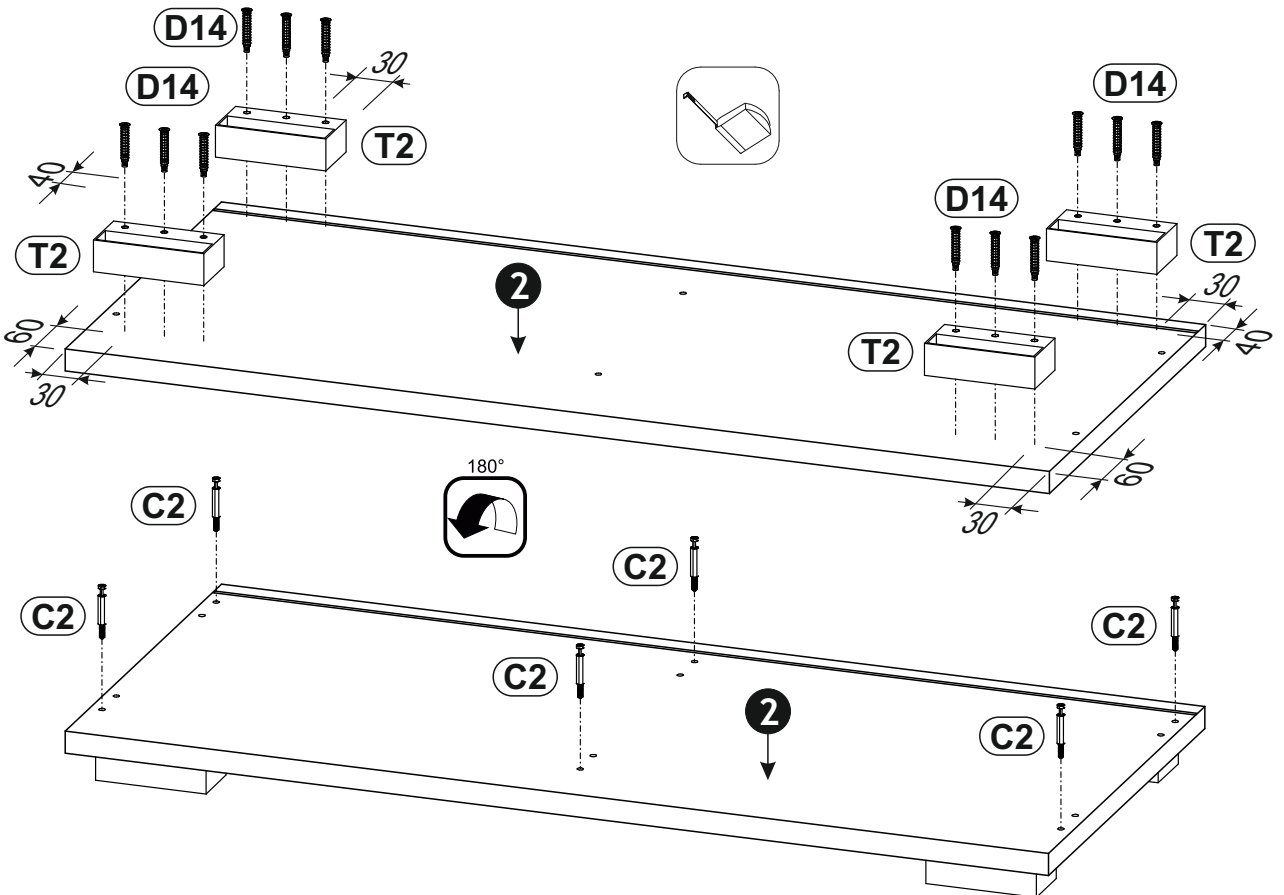
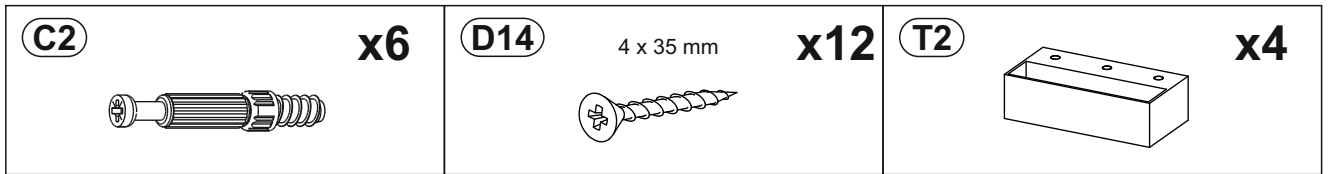

5

A0	8 x 30mm	x2	C1	18mm	x4	Q0	x8
-----------	----------	-----------	-----------	------	-----------	-----------	-----------

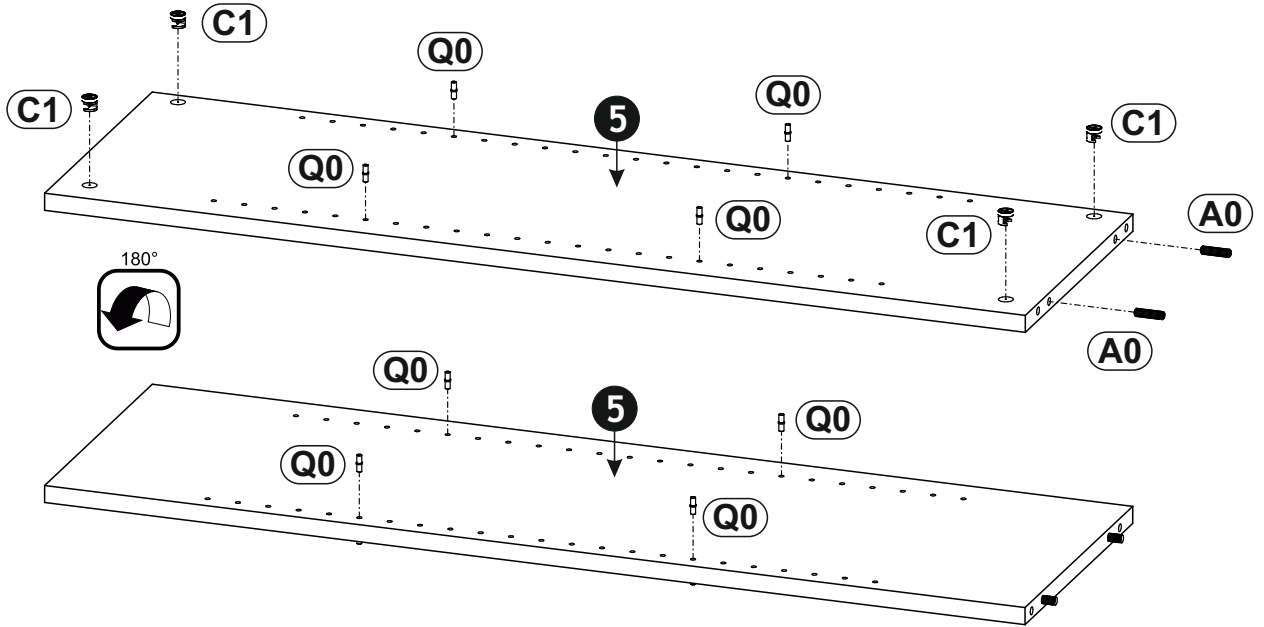

6

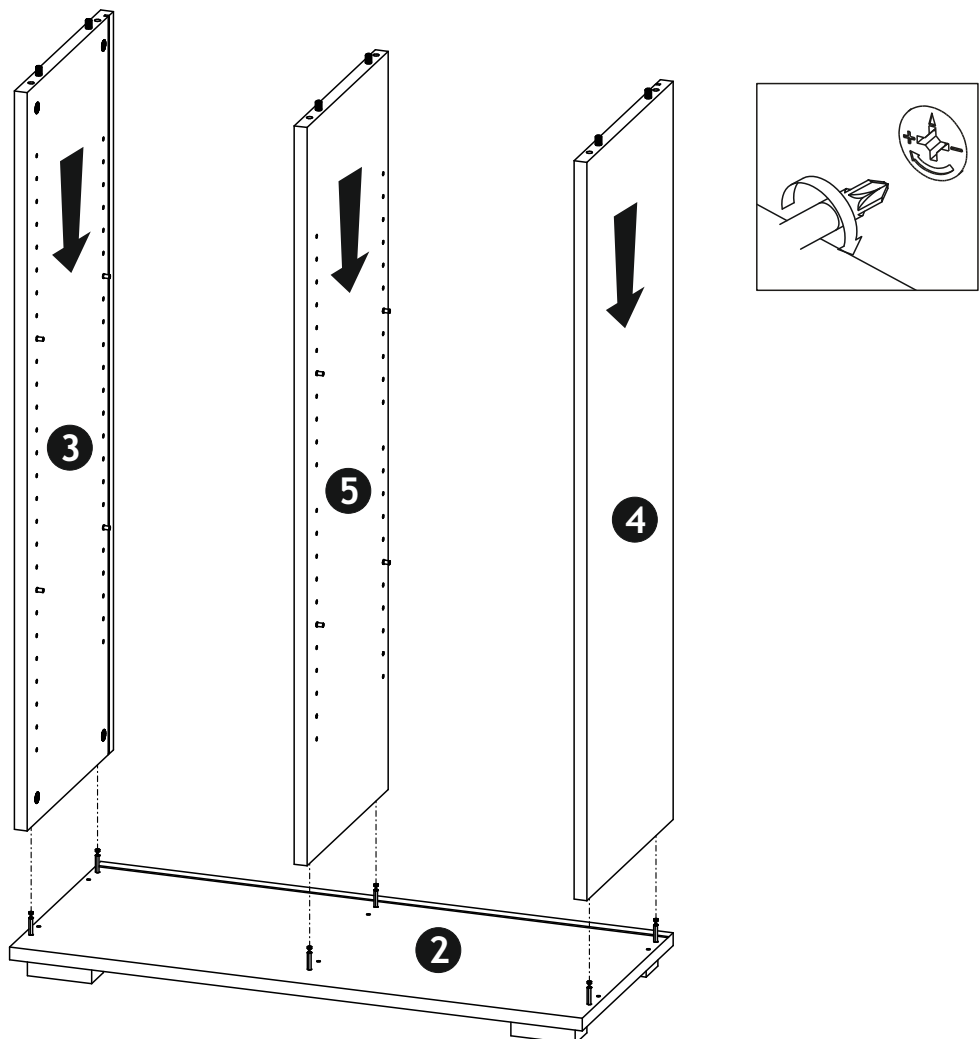

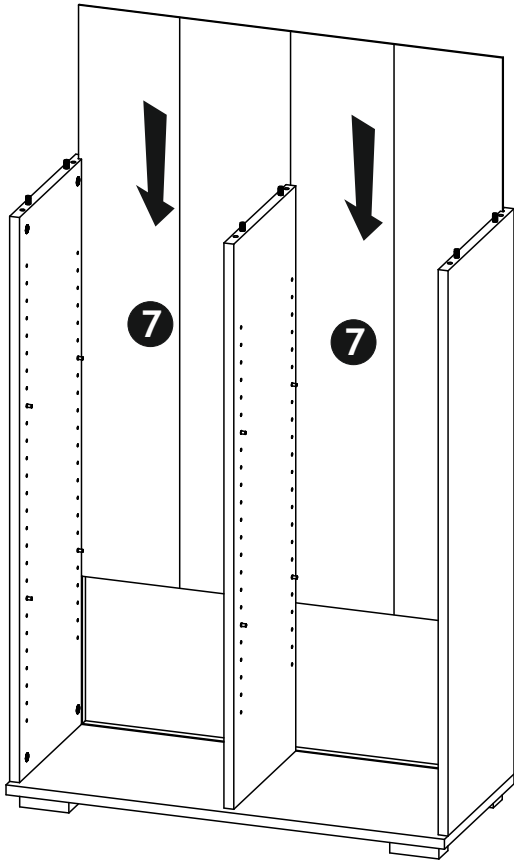

7 ▶

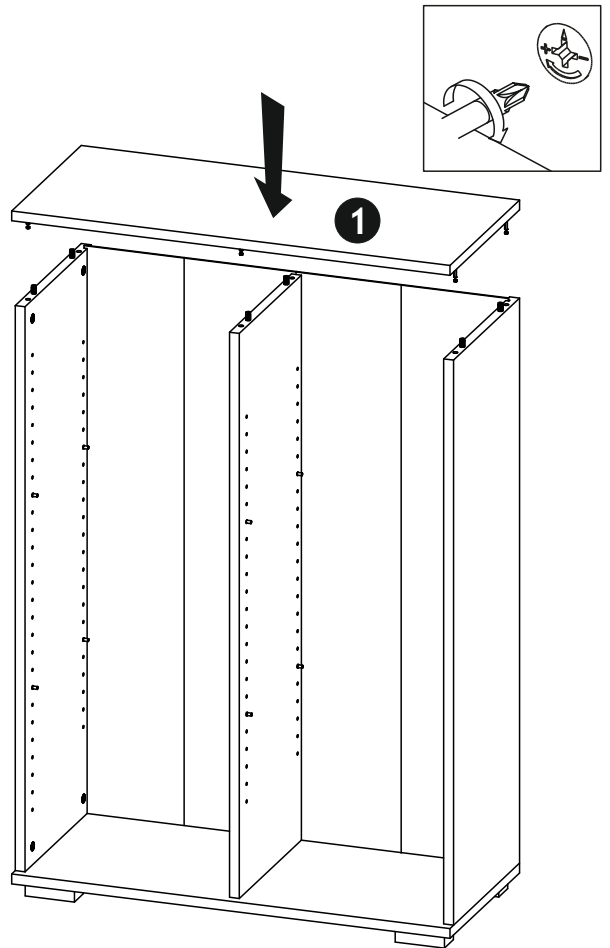

8 ▶

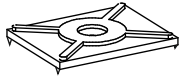

9 ▶

<p>D0 3 x 15 mm x15</p> 	<p>M1 x10</p> 	<p>M3 x5</p> 
---	---	--

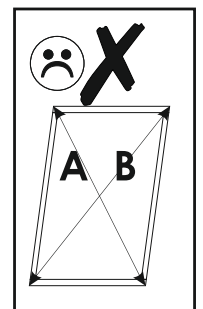
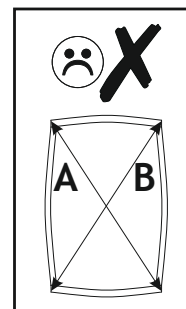
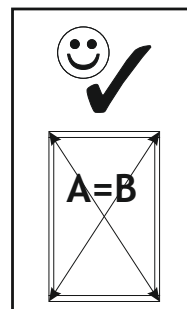
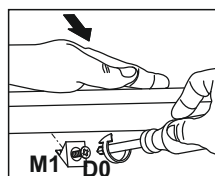
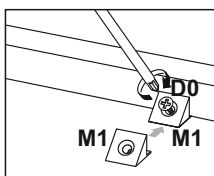
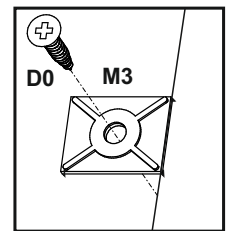
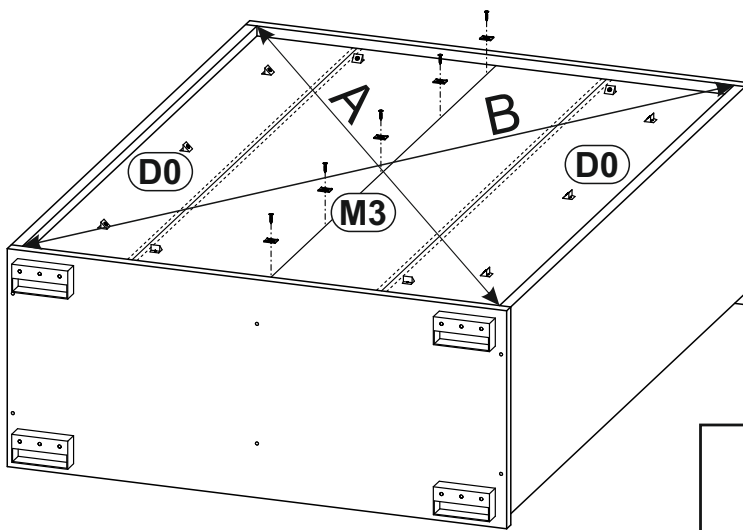

10

